

High Bay
Canopy

CH2500 Series



Applications



CH2500 Specifications

Model	Power	Voltage	Hz	Wattage	Total Lumen	Pupil Lumen ¹⁾	Luminous Efficacy	CCT	CRI	Beam Angle	Temperature	Installation Angle
CH2500-P200W	HP1	AC100~240V (AC90~264V)	50~60Hz	200W	19,600lm	37,240Plm	98lm/W	5,700K	83Ra	90° (Standard)	-40°C~60°C	0°
CH2500-P200W ¹⁾		AC120~277V (AC108~305)		200W	20,600lm	39,140Plm	103lm/W	5,700K	83Ra	20°, 60° (Option)	-40°C~60°C	0°

※ ¹⁾ The product utilized LED packages of higher lumen efficacy to raise lumen efficacy level (Over 100 lm/W)
 ※ In this catalogue, default color temperature is 5,700K and when color temperature of 3,000K is applied, total lumen and luminous efficacy decrease by 10%
 ※ Standard Deviation : Electricity Consumption ±7%, Total Lumen ±7%, Light Efficacy ±7%, CCT ±6%, CRI ±2% in this catalogue
 ※ Specifications are subject to change without prior notice. Please refer to our website for the newest specifications (www.icepipeLED.com)
 ※ 1) Pupil Lumen (有効光通量, 가시총광량, 有効全光束) -- Reference p.24(p.24 参照, p.24 참조)
 Pupil Lumen = Photopic Lumens x S/P Ratio
 ○ Photopic Lumen : 照度計測の値 / 조도계로 측정된 값 / 照度測定器で測定した値
 ○ S/P Ratio : S/P 比率, S/P 비율, S/P 比率



CR2000
CH2000
CH2500
CD800
CD1500
CD3000
CD4000
CT2000
CT2500
CT3000
CT5000
CT8000
OBB Street
CD800S
CD1500S
CD3000S
CD4000S
Omni LED
POP LED

CH2500 Series

High Bay, Canopy

Features(特点, 특징점, 特徴)



Strong against Corrosion

防腐蚀性, 부식에 강함, 腐食に強い

Strong against corrosion as its heat sink is made of copper, and stainless-steel and polycarbonate for the other parts

所有部件由铜、不锈钢、聚碳酸酯组成防腐蚀性十分优秀

방열 히트싱크를 세계최초로 구리를 사용하여 제작하고, 기타부품을 스테인레스스틸과 폴리카보네이트를 사용하여 제작하였기 때문에 부식에 강합니다
銅材質のヒートシンクとステンレス鋼、ポリカーボネートの組合で腐食に強いです



Embedded Protection Circuit

内置安全保护回路, 안전보호회로 내장, 安全保護回路内蔵

An automatic power shutdown and returning circuit, which incorporates a sensor switch that turns off power in case of a fire, abnormal high temperature, overcurrent or overvoltage, is added. It prevents secondary fire and self-damage to the product

自动切断电源的传感器在遇到火灾、异常高温、过电流、过电压等现象时会自动切断、接通电源、从而避免二次火灾及对产品本身的损伤

화재, 이상고온, 과전류, 과전압 발생시 전원을 차단하는 센서스위치를 이용한 전원 자동 차단 및 자동 복귀 회로를 추가하였습니다. 제품에 의한 2차 화재발생 및 제품의 자체 손상을 방지합니다

電源遮断スイッチが搭載され、火災、異常高温、過電流などの現象が発生した場合、電源自動遮断、復帰回路を追加により、2次災害や製品の損傷を防止します

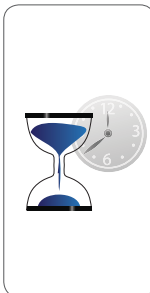

Embedded Double Power Supply

2重電源装置, 내장형 더블전원공급기, 内蔵型ダブル電源

Embedded Double Power Supply with "105°C 10,000 hours electrolysis capacitor" installed in double row arrangement fundamentally solved lifespan reduction derived by the capacitor's capacity decline to maximize lumen maintenance and overall lifespan.

采用105°C 1万小时的电解电容2重并列设计的2重电源装置、解决了因电容容量的减少导致使用寿命缩短的现象

105°C 1만시간 전해캐패시터를 2중병렬로 설치한 내장형 더블전원공급기를 사용하여 캐패시터의 용량감소로 인한 수명저하를 근본적으로 해결하였으며, LED의 광유지율을 높이고, 수명을 크게 늘렸습니다.

105°C 1万時間電解コンデンサを2重並列に搭載した内蔵型ダブル電源を使用してキャパシタの容量減少による寿命低下を根本的に解決し、LEDの光維持率を高め、寿命を大幅に増やしました

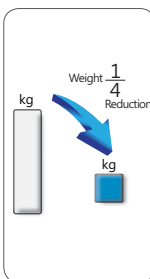

Ultra Small & Light simplifies Installation, Increases Safety

通过Ultra Small & Light使安装简单化、安全最大化, Ultra Small & Light로 설치 용이, 안전증대, Ultra Small & Lightで 設置容易, 安全確保

ICEPIPE heatsink reduced LED chip temperature and weight of the product significantly. It simplifies installation steps and increases safety

通过使用ICEPIPE的散热技术降低了LED灯珠的温度同时产品重量减轻达到安装简便、提高安全性的目的

ICEPIPE 히트싱크를 적용하여 LED Chip의 온도를 낮추면서 제품의 무게는 대폭 줄였습니다. 설치 및 시공이 용이하고 안전이 증대됩니다.

ICEPIPE 히트싱크의装着によりLED Chipの温度を下げた同時、製品の重量を軽く、設置が容易で安全性が向上しました



Ingress Protection Rating IP67

防水等级IP67, 방수등급 IP67, 防水等級IP67

By simplifying waterproof construction and equipping silicone waterproof sealing, it achieved ingress protection rating IP67 Fully protected from dust and usable in water to 1 meter depth for 30 minutes

通过改善防水构造及安装构造、将防水等级提高到IP67、不仅完全防止灰尘进入而且能够在1m水下30分钟不进水

방수구조를 단순화하고, 실리콘 방수 실링을 이용하여 IP67을 구현하였습니다 먼지로부터 완벽하게 보호, 1m이하 물 속에 잠겨서 30분간 사용 가능합니다

防水構造を単純化させてシリコン防水リングでIP67を実現しました。粉塵が内部に侵入しないし、水深1mに30分間没する事が可能です

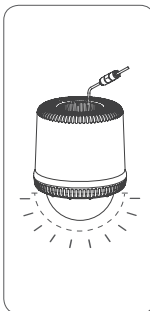

Dome Diffuser for Glare Prevention is Applicable

可选用防耀眼半球形散光灯罩, 눈부심 방지용 돔디퓨저 적용 가능, 그레아防止用ドーム型拡散カバー適用可能

The Dome Diffuser has approximately twice larger surface area compared to the Diffuser Plate, which is most effective in sites that require glare prevention.

半球形散光灯罩的表面面积比平板灯罩面积大2倍。因此、需要防耀眼现象的地方能有效地减轻耀眼现象

돔디퓨저를 적용하면 평판디퓨저보다 표면적이 약2배 가량 넓어서 눈부심을 절반으로 줄일 수 있어 눈부심 방지를 필요로 하는 현장에 효과적입니다.

ドーム型拡散カバーを適用するとフラットカバーより表面積が2倍もするので眩しさを半分に減らすことができ、グレア防止に効果的である

Composition (内部构造, 내부구조, 内部構造)

Aluminum/Copper, 알루미늄/구리, アルミ/銅

Ultralight Thermal Base

超轻量导热板, 초경량 서멀베이스, 超轻量放熱ベース

ICEPIPE is welded to Ultralight Thermal Base and is excellent in heat transfer (The World's First)

ICEPIPE直接焊接在铝板上, 的缘故导电性能非常卓越(世界首创)

초경량 서멀베이스(알루미늄)에 ICEPIPE가 금속 용접되어 열전달 우수(세계최초)

超轻量アルミ放熱ベースにICEPIPEが溶接され熱の伝導が優れてます(世界最初)

Standard - Aluminum(铝, 알루미늄, アルミ)

Option - Copper(铜, 구리, 銅)

*Highest resistance against corrosive environment

*适用于要求耐腐蝕的区域

*내식성이 요구되는 장소에 사용 권장

*耐食性が要求される場所での使用を推奨

Silicone, 有机硅塑料, 실리콘, 실리콘

Waterproof Sealing

防水密封圈, 방수씰링, 防水링

Polycarbonate /ABS, 聚碳酸酯/ABS, 폴리카보네이트/ABS, 폴리카보네트/ABS

Housing

(外壳, 하우징,ハウジング)

Stainless Steel, 不锈钢, 스테인리스틸, 스텐레스鋼

Eye-Bolt

(固定圆环, 아이볼트, Eye볼트)

Copper, 铜, 구리, 銅

ICEPIPE Heatsink

- The World's First FDP (Fluid Dynamic Pressure) Technology
- 200 Times Faster Heat Transfer Rate than Aluminum(Al)
- Maximization of Air Flow through Aerodynamic Design
- Maximization of Heat Dissipation Surface
- Value of Thermal resistance Weight Multiplier 0.32

使用了世界最新开发出的FDP (Fluid Dynamic Pressure)技术, 比铝(Al)制散热器散热速度快200倍, 通过空气动力学设计使空气流动最大化, 散热面积最大化, 热阻重量乘数0.32

세계최초로 개발된 FDP (Fluid Dynamic Pressure) 기술 적용 알루미늄(Al)보다 열전도가 200배 빠른 공기 역학적 설계로 공기흐름 최대 방열면적 최대 열저항 중량 승수값 0.32

世界最初に開発された FDP (Fluid Dynamic Pressure) 技術採用 알루미늄に比べて熱伝導率が200倍早い, 空気力学的な設計, 放熱面積拡大, 熱抵抗重量乗数値 0.32

* A Value of Thermal resistance Weight Multiplier that is less than "1" indicates a high-efficiency heatsink. 热阻重量乘数値小于1, 可称之为高效的散热器. 열저항 중량 승수값이 "1"미만이면 고효율 히트싱크입니다. 熱抵抗重量乘數值が1未満の高効率ヒートシンク搭載

Embedded Double Power Supply

2重电源装置, 내장형 더블전원공급기, 内蔵型ダブル電源

HP1

By applying the power factor correction circuit, the power factor increases to 0.93 and the DC output is stable enough to prevent flickering (voltage fluctuation under 0.2%) 105°C 10,000-hour electrolysis-capacitor is arranged in a double row to fundamentally resolve the problem of fall in lifespan due to capacity reduction of the capacitor

采用功率因数补偿电路, 使直流输出电压的变化小于0.2%防止了闪烁现象, 功率因数提高到0.93, 为了提高电源的使用寿命, 采用105°C·1万小时的电解电容2重并列设计, 解决了因电容量减少导致使用寿命缩短现象

역률보상회로를 적용하여 역률을 0.93으로 높이고, 플리커가 없도록 DC출력을 일정(전압변동 0.2% 이하)하게 하였습니다. 파워의 수명을 대폭 증가시키기 위하여 105°C 1만시간 전해개패시터를 2중 병렬로 설치하여 개패시터의 용량감소로 인한 수명저하를 근본적으로 해결하였습니다

力率補正回路を適用し、力率を0.93に高め、FlickerがないようにDC出力を安定させました(電圧変動0.2%以下) 電源の寿命を長くするために105°C 1万時間の電解コンデンサを2重並列に搭載してキャパシタの容量減少による寿命の短縮を根本的に解決しました

Glass/PC, 玻璃/PC, 유리/PC, ガラス/PC

Diffuser Plate

散光板, 확산판, 乳白色板

Glare Prevention Diffuser Plate (Optional)

防止耀眼的散光板(可选择), 눈부심방지 확산판(선택가능),眩し防止乳白色板(選択可能)

Standard - Clear PC(Poly Carbonate) 透明PC, 투명PC, 透明PC

Option - Tempered Glass

钢化玻璃, 강화유리, 強化ガラス

- Glass Diffuser 散光玻璃, 확산유리, 乳白色ガラス

- PC Diffuser 散光PC, 확산PC, 乳白色PC

- Dome Diffuser 半球形散光灯罩, 확산구, 돔-型拡散カバー

* When a Dome Diffuser or a Diffuser Plate is applied, it prevents glare, but Total Lumen will decrease approximately by 9% with a Diffuser Plate, and 2% with a Dome Diffuser, compared to a Clear Glass and a Clear PC

虽然利用散光板或半球形灯罩可以有效地防止耀眼现象, 但是光通量与使用透明玻璃和透明PC相比, 在使用散光板时约降低9%, 使用半球形灯罩时约降低2%

확산판, 돔디퓨저를 사용하면 눈부심이 방지되지만 총광량이 투명유리 및 투명PC에 비해 확산판은 약 9%, 돔디퓨저는 약 2% 정도 저하됩니다

乳白色板, 돔-型カバーで眩しきは軽減されますが、全光束が透明ガラス及び透明PCに比べると乳白色板使った時約9%低下、ドーム型カバー使った時約2%低下する。

Polycarbonate /ABS 聚碳酸酯/ABS, 폴리카보네이트/ABS, 폴리카보네트/ABS

Cover

盖子, 커버, 커버

CH2500 Series

High Bay, Canopy

CH2500-P200W

Replacement for Metal Halide 400~600W, 可代替400~600W金属卤化物灯, 메탈할라이드 400~600W 대체가능, メタルハライド 400~600W 相当

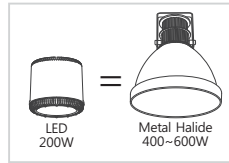

Light Distribution Curve

配光曲线, 배광곡선, 配光曲線

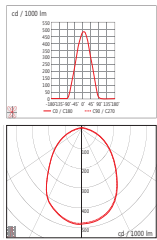

Illumination Intensity

照度示意图, 직하조도표, 直下照度

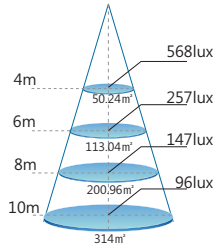

Applications (适用范围, 용도, 適用範圍)

- High Bay (顶棚, 고천장등, 高天井)
- Canopy (吊顶, 캐노피등, キャビ어)

Specifications (参数, 사양, 仕様)

1. Input Voltage (输入电压, 입력전압, 入力電圧): AC100~240V (AC90~264V), AC120~277V (AC108~305V)
2. Installation (安装, 설치, 設置): Chain (链条, 체인, チェーン)
3. Wattage (消耗功率, 소비전력, 消費電力): 200W
4. Total Lumen (光通量, 총광량, 全光束): 19,600lm (17,640lm)
5. Luminous Efficacy (光效, 광효율, 光効率): 98lm/W (88lm/W)
6. Pupil Lumens (有效光通量, 가시총광속, 有効全光束): 37,240Plm (33,516Plm)
7. CCT (色温, 색온도, 色温度): 5,700K (3,000K)
8. CRI (显色性, 연색성, 演色性): 83Ra
9. Beam Angle (照射角度, 조사각도, 비ーム각): 90° (Standard) / 20°, 60° (Option)
10. IP Rating (防水等级, 방수등급, 防水等級): IP67

Option : Diffuser Plate Applied (采用散光罩时, 확산판 적용, 拡散カバー付)

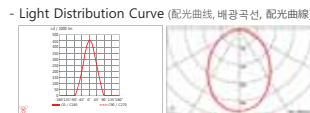

※ Compared to Clear Plate, Transmittance Rate Decreases 9%
与透明罩相比透光率减少约9%, Clear Plate 적용시 보다 광투과율이 약 9% 감소. 透明カバーへの透過率が約9%減少

Please visit our website and check the Illumination Intensity

在公司网页 (www.icepipeLED.com) 上可以看到照度示意图
당사 홈페이지 (www.icepipeLED.com) 를 방문하시면 직하조도표를 보실수 있습니다.
当社のホームページ (www.icepipeLED.com) で取付け直下照度をご覧いただけます

Option : Dome Diffuser Applied (采用半球散光罩时, 확산구 적용, 돔型拡散カバー付)

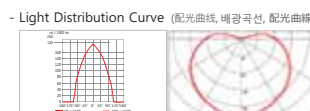

※ Compared to Clear Plate, Transmittance Rate Decreases 2%
与透明罩相比透光率减少约2%, Clear Plate 적용시 보다 광투과율이 약 2% 감소. 透明カバーへの透過率が約2%減少

Please visit our website and check the Illumination Intensity

在公司网页 (www.icepipeLED.com) 上可以看到照度示意图
당사 홈페이지 (www.icepipeLED.com) 를 방문하시면 직하조도표를 보실수 있습니다.
当社のホームページ (www.icepipeLED.com) で取付け直下照度をご覧いただけます

Simulation Example

1. Model (型号名称, 모델명, モデル): CH2500-P200W
2. Area (照射面积, 조사면적, 照射面積): 1,000m² (40m×25m)
3. Installation Height (安装高度, 설치높이, 設置高さ): 6m
4. Lamp Quantity (灯具数量, 등수량, 照明数量): 50 (5×10)
5. Average Floor Illuminance: 1,020lux
(Maintenance factor: 80%, Interior Reflection Factor: 70% - Floor, Ceiling, Wall)
平均照度: 1,020lux (光维持率: 80%, 反射率: 70% - 地面・天花板・墙壁)
바닥평균조도: 1,020lux (유지보수율: 80%, 실내반사율: 70% - 바닥, 천장, 벽)
床平均照度: 1,020lux (保守率: 80%, 反射率: 70% - 床, 天井, 壁)

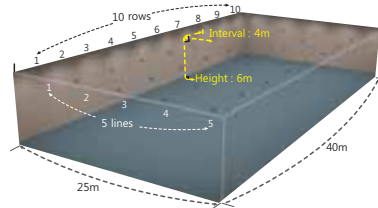

Required Lamp Qty (Area 1,000m² (40m×25m))

所需灯具数量 (照射面积, 등의 필요수량 (조사면적), 照明の必要な数量 (面積) (1,000m² (40m×25m))

Classification 区分, 구분, 区分	Average Floor Illuminance 地面 平均照度/바닥 평균조도 床平均照度	Number of Lamps by Height 根据高度的所需数量, 높이에 따른 필요수량, 高さによる必要な数量				
		4m	6m	8m	10m	15m
Low Lumen (Factory, Warehouse) 较低亮度的工厂·仓库, 낮은 밝기 (공장, 창고) 低い明るさ(工場, 倉庫)	100lux	5EA	5EA	5EA	6EA	7EA
	200lux	10EA	11EA	11EA	12EA	14EA
Normal Lumen (Factory, Warehouse) 普通亮度的工厂·仓库, 보통 밝기 (공장, 창고) 普通明るさ(工場, 倉庫)	300lux	15EA	16EA	17EA	18EA	21EA
	400lux	20EA	22EA	23EA	24EA	28EA
High Lumen (Factory, Warehouse) 较高亮度的工厂·仓库, 밝은 밝기 (공장, 창고) 高い明るさ(工場, 倉庫)	500lux	26EA	27EA	29EA	30EA	35EA
	600lux	31EA	33EA	35EA	37EA	42EA

Weight and Dimension

1. Weight (重量, 무게, 重量): 3.2Kg
2. Dimensions: Φ276mm X 261mm(H)
产品尺寸, 제품사이즈, 製品サイズ
3. Packaging Size: 315mm(W) X 315mm(L) X 295mm(H)
单个产品包装, 개별박스포장, 小箱梱包

Usage Conditions (使用条件, 사용조건, 使用条件)

1. Indoors, Outdoors (with ceilings)
室内·室外(屋檐), 실내, 실외(천장 있는 곳), 屋内, 屋外(軒下)
2. Operation Temperature (使用温度, 사용온도, 使用温度): -40°C~60°C
3. Admitted Installation Angle: Downward 0°
适用安装角度: 垂直 0°, 설치허용각도: 하향 0°, 設置許容角度: 鉛直方向 0°

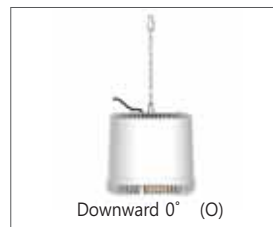

Dimming (调光, 조광, 調光)

1. Dimmer Incompatible (禁止使用调光器, 디머 사용불가, 調光器使用不可)



※ In this catalogue, default color temperature is 5,700K and when color temperature of 3,000K is applied, total lumen and luminous efficacy decrease by 10%

※ Standard Deviation: Electricity Consumption ±7%, Total Lumen ±7%, Light Efficacy ±7%, CCT ±6%, CRI ±2% in this catalogue

※ Specifications are subject to change without prior notice. Please refer to our website for the newest specifications (www.icepipeLED.com)

CH2500-P200W ^{L+}

Replacement for Metal Halide 400~600W, 可代替400~600W金属卤化物灯, 메탈할라이드 400~600W 대체가능, メタルハライド 400~600W 相当

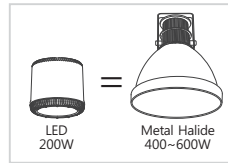

Light Distribution Curve

配光曲线, 배광곡선, 配光曲線

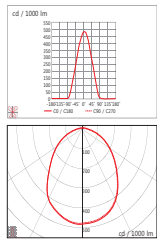

Illumination Intensity

照度示意图, 직하조도표, 直下照度

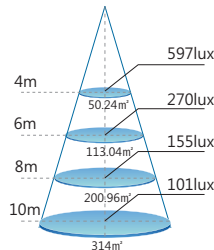

Applications (适用范围, 용도, 適用範圍)

- High Bay (顶棚, 고천장등, 高天井)
- Canopy (吊顶, 캐노피등, 캐노피)

Specifications (参数, 사양, 仕様)

1. Input Voltage (输入电压, 입력전압, 入力電圧): AC100~240V (AC90~264V), AC120~277V (AC108~305V)
2. Installation (安装, 설치, 設置): Chain (链条, 체인, チェーン)
3. Wattage (消耗功率, 소비전력, 消費電力): 200W
4. Total Lumen (光通量, 총광량, 全光束): 20,600lm (18,540lm)
5. Luminous Efficacy (光效, 광효율, 光効率): 103lm/W (93lm/W)
6. Pupil Lumens (有效光通量, 가시총광속, 有効全光束): 39,140Plm (35,226Plm)
7. CCT (色温, 색온도, 色温度): 5,700K (3,000K)
8. CRI (显色性, 연색성, 演色性): 83Ra
9. Beam Angle (照射角度, 조사각도, 비ーム角): 90° (Standard) / 20°, 60° (Option)
10. IP Rating (防水等级, 방수등급, 防水等級): IP67

Option : Diffuser Plate Applied (采用散光罩时, 확산판 적용, 拡散カバー付)

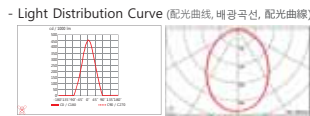

※ Compared to Clear Plate, Transmittance Rate Decreases 9%
与透明罩相比透光率减少约9%, Clear Plate 적용시 보다 광투과율이 약 9% 감소, 透明カバーより透過率が約9%減少
-Please visit our website and check the Illumination Intensity
在公司网页(www.icepipeLED.com)上可以看到照度示意图视频,
당사 홈페이지 (www.icepipeLED.com) 를 방문하시면 직하조도표를 보실수 있습니다.
当社のホームページ(www.icepipeLED.com) で取付寸面下照度をご覧いただけます

Option : Dome Diffuser Applied (采用半球散光罩时, 확산구 적용, 돔型拡散カバー付)

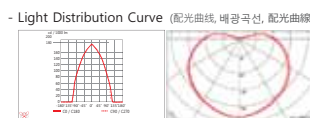

※ Compared to Clear Plate, Transmittance Rate Decreases 2%
与透明罩相比透光率减少约2%, Clear Plate 적용시 보다 광투과율이 약 2% 감소, 透明カバーより透過率が約2%減少
-Please visit our website and check the Illumination Intensity
在公司网页(www.icepipeLED.com)上可以看到照度示意图视频,
당사 홈페이지 (www.icepipeLED.com) 를 방문하시면 직하조도표를 보실수 있습니다.
当社のホームページ(www.icepipeLED.com) で取付寸面下照度をご覧いただけます

Simulation Example

1. Model (型号名称, 모델명, モデル): CH2500-P200W ^{L+}
2. Area (照射面积, 조사면적, 照射面積): 1,000m² (40m×25m)
3. Installation Height (安装高度, 설치높이, 設置高さ): 6m
4. Lamp Quantity (灯具数量, 등수량, 照明数量): 50(5x10)
5. Average Floor Illuminance : 1,070lux
(Maintenance factor : 80%, Interior Reflection Factor : 70% - Floor, Ceiling, Wall)
平均照度: 1,070lux (光维持率: 80%, 反射率: 70% - 地面·天花板·墙壁)
바닥평균조도: 1,070lux (유지보수율: 80%, 실내반사율: 70% - 바닥, 천장, 벽)
床平均照度: 1,070lux (保守率: 80%, 反射率: 70% - 床, 天井, 壁)

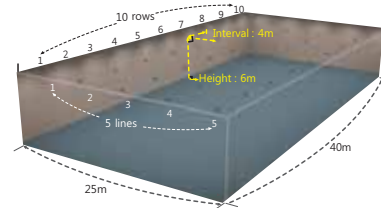

Required Lamp Q'ty (Area 1,000m² (40m×25m))

所需灯具数量(照射面积, 등의 필요수량(조사면적), 照明の必要な数量(面積)(1,000m² (40m×25m))

Classification 区分, 구분, 区分	Average Floor Illuminance 地面平均照度, 바닥 평균조도, 床平均照度	Number of Lamps by Height 根据高度的所需数量, 높이에 따른 필요수량, 高さによる必要な数量				
		4m	6m	8m	10m	15m
Low Lumen (Factory, Warehouse) 较低亮度的(工厂·仓库), 낮은 밝기 (공장, 창고) 低照度法(工場, 倉庫)	100lux	5EA	5EA	5EA	6EA	6EA
	200lux	9EA	10EA	11EA	11EA	13EA
Normal Lumen (Factory, Warehouse) 普通亮度的(工厂·仓库), 보통 밝기 (공장, 창고) 普通照度法(工場, 倉庫)	300lux	14EA	15EA	16EA	17EA	20EA
	400lux	19EA	21EA	22EA	23EA	26EA
High Lumen (Factory, Warehouse) 较高亮度的(工厂·仓库), 밝은 밝기 (공장, 창고) 高照度法(工場, 倉庫)	500lux	24EA	26EA	27EA	29EA	33EA
	600lux	29EA	31EA	33EA	35EA	40EA

Weight and Dimension

1. Weight (重量, 무게, 重量): 3.2Kg
2. Dimensions (尺寸, 제품사이즈, 製品サイズ): Φ276mm X 261mm(H)
3. Packaging Size : 315mm(W) X 315mm(L) X 295mm(H)
单个产品包装, 개별박스포장, 小箱梱包

Usage Conditions (使用条件, 사용조건, 使用条件)

1. Indoors, Outdoors (with ceilings)
室内·室外(屋檐), 실내, 실외(천장 있는 곳), 屋内, 屋外(軒下)
2. Operation Temperature (使用温度, 사용온도, 使用温度): -40°C~60°C
3. Admitted Installation Angle : Downward 0°
适用安装角度: 垂直 0°, 설치허용각도: 하향 0°, 設置許容角度: 鉛直方向 0°

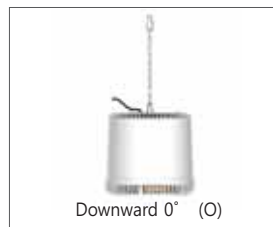

Dimming (调光, 조광, 調光)

1. Dimmer Incompatible (禁止使用调光器, 디머 사용불가, 調光器使用不可)



※ In this catalogue, default color temperature is 5,700K and when color temperature of 3,000K is applied, total lumen and luminous efficacy decrease by 10%
※ Standard Deviation : Electricity Consumption ±7%, Total Lumen ±7%, Light Efficacy ±7%, CCT ±6%, CRI ±2% in this catalogue
※ Specifications are subject to change without prior notice. Please refer to our website for the newest specifications (www.icepipeLED.com)

CH2500 Series Installation Type(安装形式, 설치타입, 設置タイプ)

High Bay

Install ① CH2500 + Chain + Hook + FMB (Flange Mount Bracket)

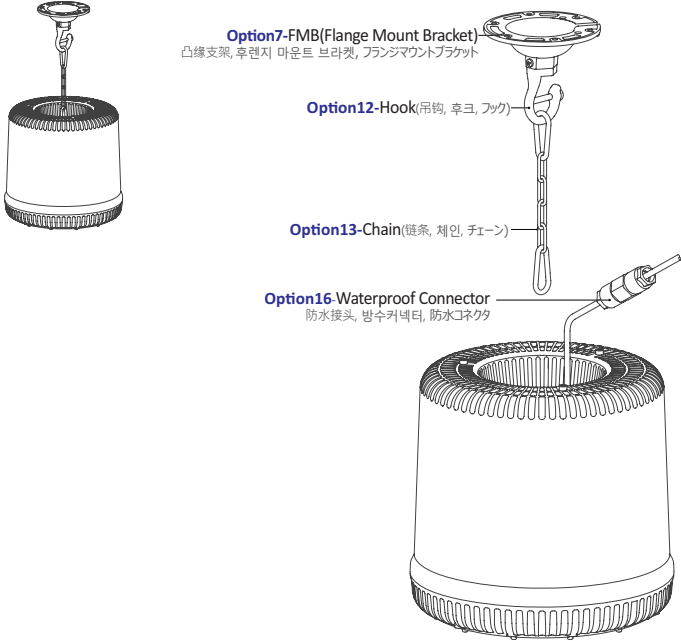

Install ①-1 Dome Diffuser 1 Install ①-2 Reflector

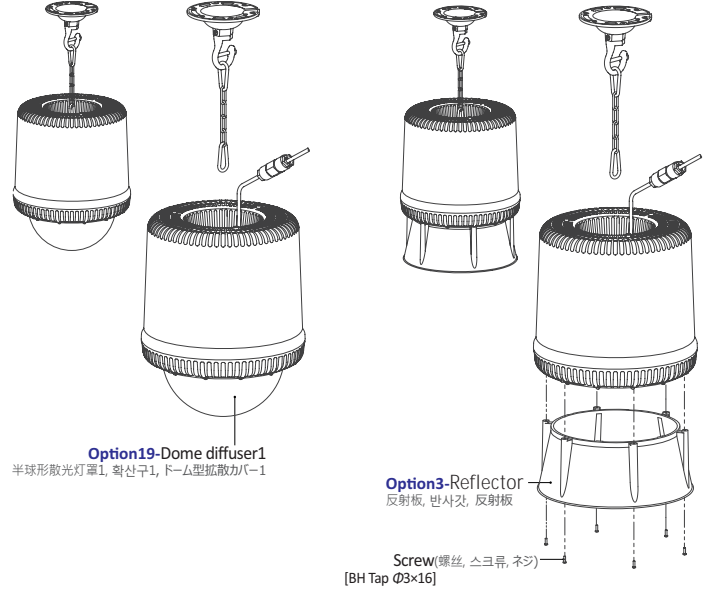

High Bay

Install ② CH2500 + Clear Shade + Chain + Hook + FMB (Flange Mount Bracket)

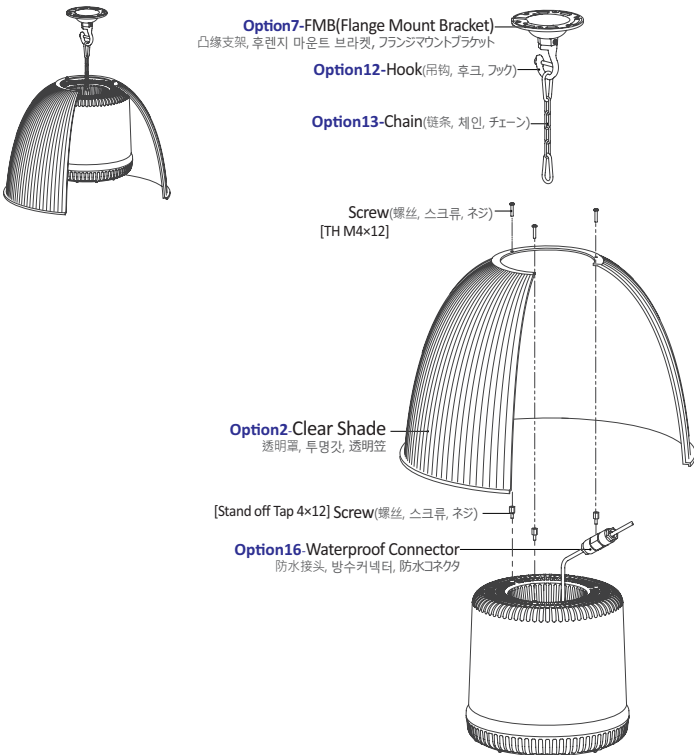



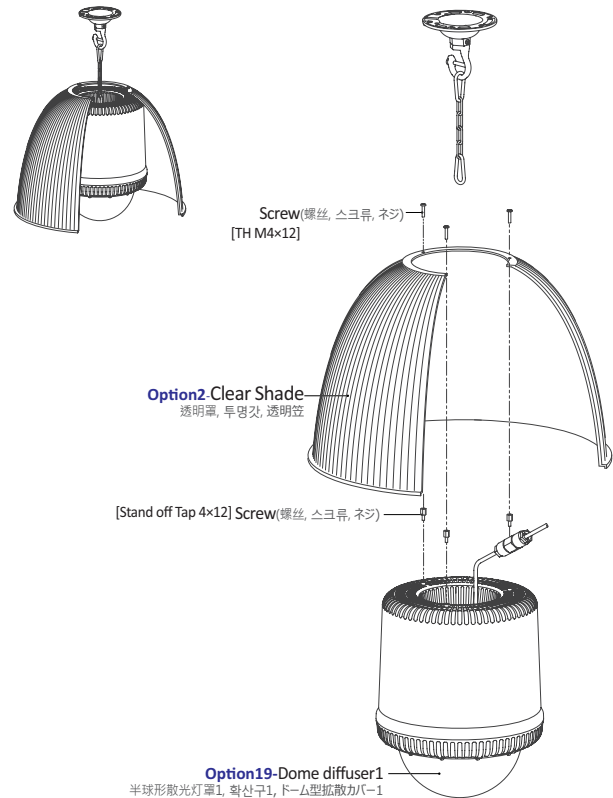





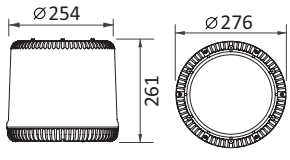
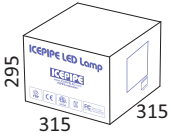
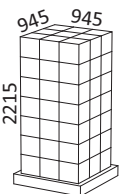

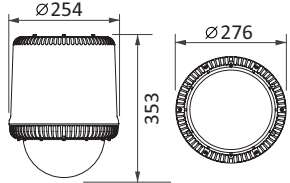
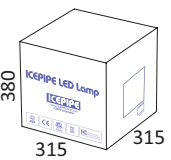

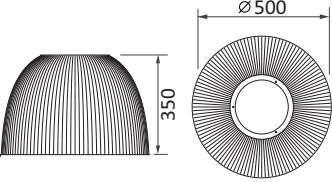
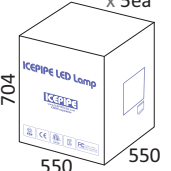
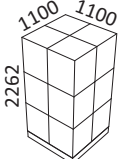
Install ②-1 Dome Diffuser 1

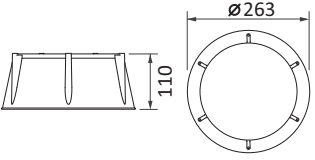
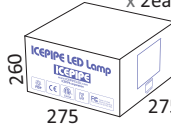
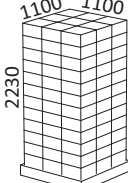

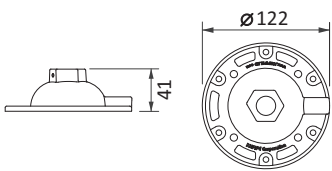

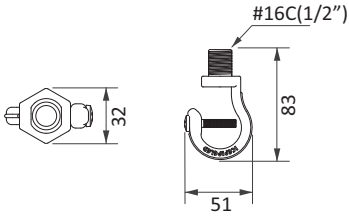

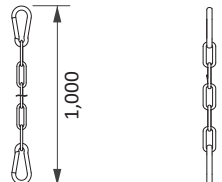

CR2000
CH2000
CH2500
CD800
CD1500
CD3000
CD4000
CT2000
CT2500
CT3000
CT5000
CT8000
OBB Street
CD800S
CD1500S
CD3000S
CD4000S
Omni LED
POP LED

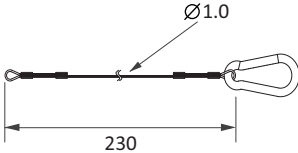
CH2500 Series Options

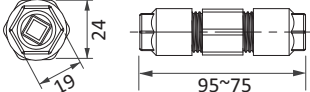
Components 部 件, 부 품, 部 品	Description 说 明, 설 명, 說 明	Dimensions 外 观 尺 寸, 외 관 치 수, 外 觀 寸 法 图	Box size 包 装 尺 寸, 박 스 사 이 즈, 梱 包 사 이 즈	Pallet size 托 盘 规 格, 팔 레 트 사 이 즈, 팔 레 트 사 이 즈
Main CH2500 	1. Weight : 3.2Kg 2. Material : Aluminum, Plastic(PC/ABS), Copper			1 x 3R x 3R x 7L = 63ea 
Main + Dome Diffuser 	1. Weight : 3.4Kg 2. Material : Aluminum, Plastic(PC/ABS), Copper			1 x 3R x 3R x 5L = 45ea 
Option 2  Clear Shade 透明罩, 투 명 갓, 透 明 笠	1. Weight : 1,670g 2. Material : Plastic(PC)		x 5ea 	5 x 2R x 2R x 3L = 60ea 
Option 3  Reflector 反 射 板, 반 사 갓, 反 射 板	1. Weight : 300g 2. Material : Plastic(PC/ABS)		x 2ea 	2 x 4R x 4R x 8L = 256ea 
Option 7  Flange Mount Bracket 凸 缘 支 架, 후 렌 지 마운 트 브 러 켓, 프 랑 시 마운 트 브 러 켓	1. Weight : 148g 2. Material : Aluminum		—	—
Option 12  Hook 吊 钩, 후 크, 후 크	1. Weight : 50g 2. Material : Aluminum		—	—
Option 13  Chain 链 条, 체 인, 체 인	1. Weight : 140g 2. Material : Stainless Steel		—	—

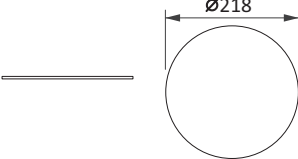
CH2500 Series Options

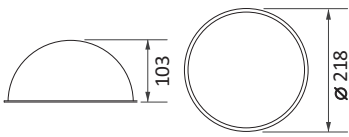
Components 部件, 부품, 部品	Description 说明, 설명, 説明	Dimensions 外观尺寸, 외관치수, 外觀寸法図	Box size 包装尺寸, 박스사이즈, 梱包サイズ	Pallet size 托盘规格, 팔레트사이즈, 팔렛트사이즈
<p>Option 15</p>  <p>Safety Wire 安全挂钩, 안전고리, 落下防止ワイヤー</p>	<p>1. Weight : 28g 2. Material : Stainless Steel</p>	 <p>Ø1.0 230</p>	—	—
<p>Option 16</p>  <p>Waterproof Connector 防水接头, 방수커넥터, 防水コネクタ</p>	<p>1. Weight : 31g 2. Material : Plastic(PVC/PE)</p>	 <p>24 19 95~75</p>	—	—
<p>Option 17</p>  <p>Diffuser Plate 1 散光板, 확산판, 乳白色板</p>	<p>1. Weight : 90g(PC), 293g(Glass) 2. Material : Plastic(PC), Glass</p> <p>※ It must be ordered along with CH2500 请与CH2500灯具一起订购 CH2500 본체와 함께 주문하십시오 CH2500本体と一緒に注文してください</p>	 <p>Ø218</p>	—	—
<p>Option 19</p>  <p>Dome Diffuser 1 半球形散光灯罩1, 확산구1, 돔型拡散力バー1</p>	<p>1. Weight : 165g 2. Material : Plastic(PC)</p> <p>※ It must be ordered along with CH2500 请与CH2500灯具一起订购 CH2500 본체와 함께 주문하십시오 CH2500本体と一緒に注文してください</p>	 <p>103 Ø 218</p>	—	—